



**Cambridge International Examinations**  
Cambridge International General Certificate of Secondary Education

CANDIDATE  
NAME

CENTRE  
NUMBER

--	--	--	--	--	--

CANDIDATE  
NUMBER

--	--	--	--	--



**COMPUTER STUDIES**

**0420/11**

Paper 1

**October/November 2014**

**2 hours 30 minutes**

Candidates answer on the Question Paper.

No Additional Materials are required.

**READ THESE INSTRUCTIONS FIRST**

Write your Centre number, candidate number and name on all the work you hand in.

Write in dark blue or black pen.

You may use an HB pencil for any diagrams, graphs or rough working.

Do not use staples, paper clips, glue or correction fluid.

**DO NOT WRITE IN ANY BARCODES.**

Answer **all** questions.

No marks will be awarded for using brand names of software packages or hardware.

At the end of the examination, fasten all your work securely together.

The number of marks is given in brackets [ ] at the end of each question or part question.

This document consists of **23** printed pages and **1** blank page.

1 State **three** features of a typical operating system.

1 .....

.....

2 .....

.....

3 .....

..... [3]

2 Many companies across the world have increasingly introduced computer systems into the office environment. This has had a big effect on employees.

(a) Identify **three** ways in which this new technology has affected employees. In **each** case, explain why it has had an impact.

1 .....

.....

impact .....

.....

.....

2 .....

.....

impact .....

.....

.....

3 .....

.....

impact .....

.....

..... [6]

(b) Describe **two** health risks associated with increased use of computers.

1 .....

.....

.....

2 .....

.....

.....[2]

3 The following **five** statements about Internet security are incomplete:

- (i) Illegal access to a computer system is known as < - - - - **(a)** - - - - >.
- (ii) < - - - - **(b)** - - - - > are programs that self-replicate (copy themselves) and are designed to disrupt computer systems.
- (iii) < - - - - **(c)** - - - - > is where a user is sent legitimate-looking emails; as soon as the email is opened and the recipient clicks on the embedded link, they are sent to a fake website.
- (iv) Software that monitors key presses on a user's keyboard, and relays the information back to the person who sent the software, is known as < - - - - **(d)** - - - - >.
- (v) < - - - - **(e)** - - - - > is malicious code or software installed on the hard drive of a user's computer or on a web server; the code or software will re-direct the user to a fake website without their knowledge.

Complete the **five** statements using words from the following list:

- cookies
- hacking
- pharming
- phishing
- spam
- spyware
- viruses
- web browsers

(a) .....[1]

(b) .....[1]

(c) .....[1]

(d) .....[1]

(e) .....[1]

4 Six statements and six values are shown below.

Each statement will generate one possible value.

Draw a line to link each statement to its correct value.

statement	value												
number of times the following loop operates: count = 1 <b>repeat</b> <b>input</b> x count = count + 1 <b>until</b> count = 5	1												
the number of bits that make up a byte	4												
base 10 (denary) value of the following binary number: <table border="1" data-bbox="341 1070 719 1144"> <tr> <td>32</td> <td>16</td> <td>8</td> <td>4</td> <td>2</td> <td>1</td> </tr> <tr> <td>0</td> <td>0</td> <td>1</td> <td>1</td> <td>1</td> <td>1</td> </tr> </table>	32	16	8	4	2	1	0	0	1	1	1	1	5
32	16	8	4	2	1								
0	0	1	1	1	1								
the number of tracks on the single side of a CD-R	8												
number of minutes to upload a 75 Mbyte file at 2 megabits/second upload speed	10												
If there are $2^x$ bytes in a Kbyte, what is the value of X?	15												

[5]

5 Johan wants to write an article on how Satellite Navigation systems (Sat Nav) use GPS technology.

- (a) He sends out a questionnaire to find out people's knowledge of how these systems work. Three of the questions on his questionnaire are shown below:

<i>Sat Nav devices send signals to the global positioning satellites</i>	<b>TRUE</b>	<b>FALSE</b>
<i>Sat Nav accurately measures vehicle speed using satellite position and accurate timing</i>	<b>TRUE</b>	<b>FALSE</b>
<i>Satellites tell the Sat Nav which direction the vehicle should take</i>	<b>TRUE</b>	<b>FALSE</b>

Put a circle around **TRUE** or **FALSE** for each of the three questions to indicate the correct answers Johan should receive. [3]

- (b) Johan also wants to include an explanation as to why Sat Nav systems sometimes give incorrect instructions.

Give **two** reasons why this might occur.

1 .....

.....

2 .....

..... [2]

6 The following section of a pseudocode algorithm should:

- input 500 numbers
- generate a ratio called **k**
- output each value of **k**
- output how many numbers were larger than 10

```
10 total = 1
20 FOR x = 1 TO 500
30     IF number < 10 THEN total = total + 1
40     k = x / number
50     x = x + 1
60     OUTPUT k
70 NEXT x
80 OUTPUT x
```

(a) There are **five** errors in the above code.

Locate these errors and suggest a correction.

error 1 .....

correction .....

.....

error 2 .....

correction .....

.....

error 3 .....

correction .....

.....

error 4 .....

correction .....

.....

error 5 .....

correction .....

.....[5]

- (b) The corrected algorithm was converted to a computer program and run. However, after several numbers were input, the program stopped and an error message was generated, showing that there was a further error at line 40 ( $k = x / \text{number}$ ).

State what could cause this error to occur.

.....  
.....

Suggest a change to line 40 to overcome this problem.

.....  
.....  
..... [2]

7 A digital camera contains a microprocessor. The camera's specification includes:

- 20 megapixel resolution
- 32 gigabyte memory card
- autofocus facility

(a) A more expensive model of the camera has 40 megapixel resolution.

(i) Describe **one** advantage of increasing the resolution.

.....  
.....[1]

(ii) Describe **one** disadvantage of having 40 megapixel resolution.

.....  
.....[1]

(b) (i) Describe the type of memory used in the memory card.

.....  
.....[1]

(ii) Give **one** benefit of using this type of memory.

.....  
.....[1]

(c) (i) What is the meaning of the term pixel?

.....  
.....[1]

(ii) If a compressed image file requires an average of 1 byte per pixel, what is the maximum number of photos that can be stored on the memory card?

.....  
.....[1]

(d) Apart from autofocus, describe **one** other feature you would expect to see on a digital camera controlled by a microprocessor.

.....  
.....[1]



8 The doors on a train are opened and closed automatically. Motors are used to operate the doors. The system is controlled by a microprocessor.

Each door has a sensor which detects if a passenger enters or leaves the train as the doors are closing. If a passenger is detected, the doors are automatically re-opened.

(a) Name a sensor which could be used to detect a passenger.

.....[1]

(b) If the sensor in one of the doors fails, describe a safety mechanism to prevent injury to a passenger.

.....  
.....  
.....[1]

(c) Describe how the sensors, microprocessor and door motors interact to ensure a passenger is not trapped in a closing door.

.....  
.....  
.....  
.....  
.....  
.....  
.....  
.....  
.....  
.....  
.....  
.....  
.....  
.....  
.....  
.....  
.....  
.....  
.....[4]

9 A floor turtle uses the following commands:

Command	Description
FORWARD $n$	Move $n$ cm in a forward direction
BACKWARD $n$	Move $n$ cm in a backward (reverse) direction
RIGHT $t$	Turn right through $t$ degrees
LEFT $t$	Turn left through $t$ degrees
PENUP	Lift the drawing pen up
PENDOWN	Lower the drawing pen down
REPEAT $x$	Repeat the next set of instructions $x$ times
ENDREPEAT	Finish the REPEAT loop

In the following grid, each of the squares represents 10 cm by 10 cm:

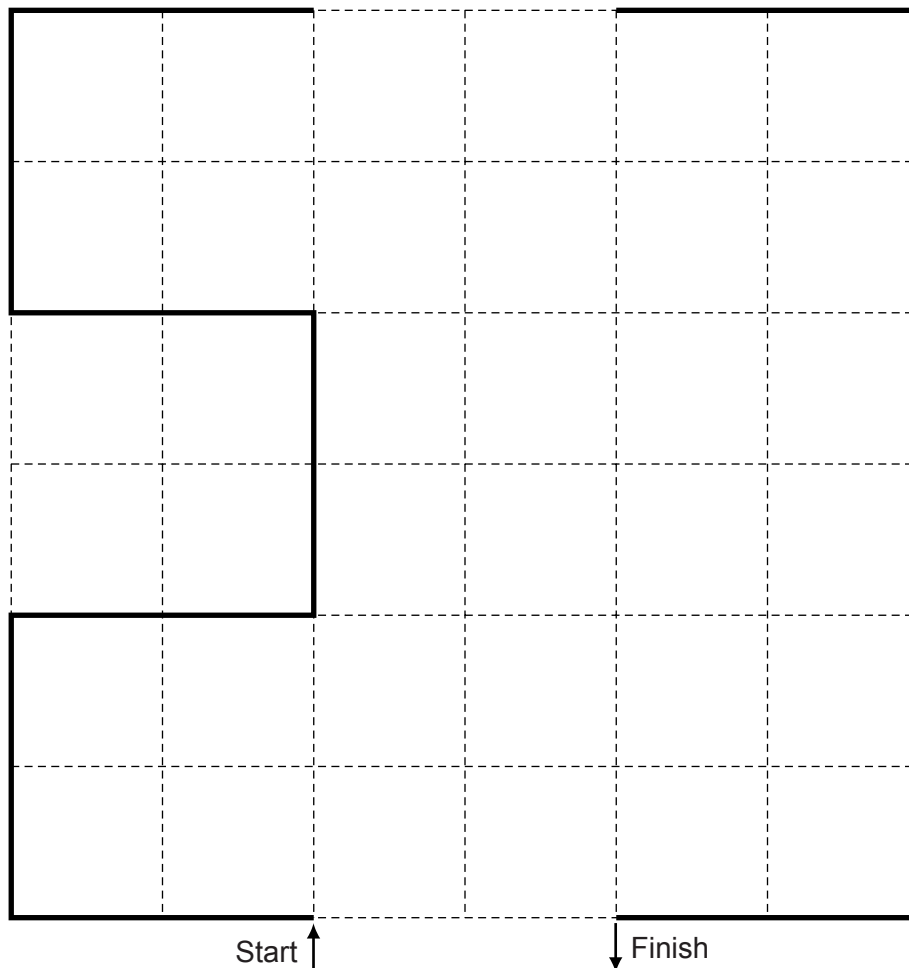

Complete the set of instructions to draw the shape shown on the left:

**1 PENDOWN**

**2 LEFT 90**

**3 REPEAT 2**

- 4 - - - - -
- 5 - - - - -
- 6 - - - - -
- 7 - - - - -
- 8 - - - - -
- 9 - - - - -
- 10 - - - - -
- 11 - - - - -
- 12 - - - - -
- 13 - - - - -
- 14 - - - - -
- 15 - - - - -
- 16 - - - - -
- 17 - - - - -
- 18 - - - - -
- 19 - - - - -
- 20 - - - - -
- 21 - - - - -
- 22 - - - - -
- 23 - - - - -
- 24 - - - - -
- 25 - - - - -

[6]

- 10 (a) The flowchart on the next page shows how barcodes are used in a supermarket to find product information and to produce orders for new stock automatically. Several statements are missing from the flowchart.

Complete the flowchart, using item numbers **only** from the list below.

Item number	Description
1	is barcode found?
2	is barcode read?
3	is flag for this product = 1?
4	is number in stock $\leq$ re-order value?
5	key in the barcode manually
6	locate price and product information from file
7	output an error message
8	output order request for new stock
9	output receipt and itemised bill
10	reduce number in stock by 1 and write new value back to the record
11	search database for barcode
12	set flag for this product to 1

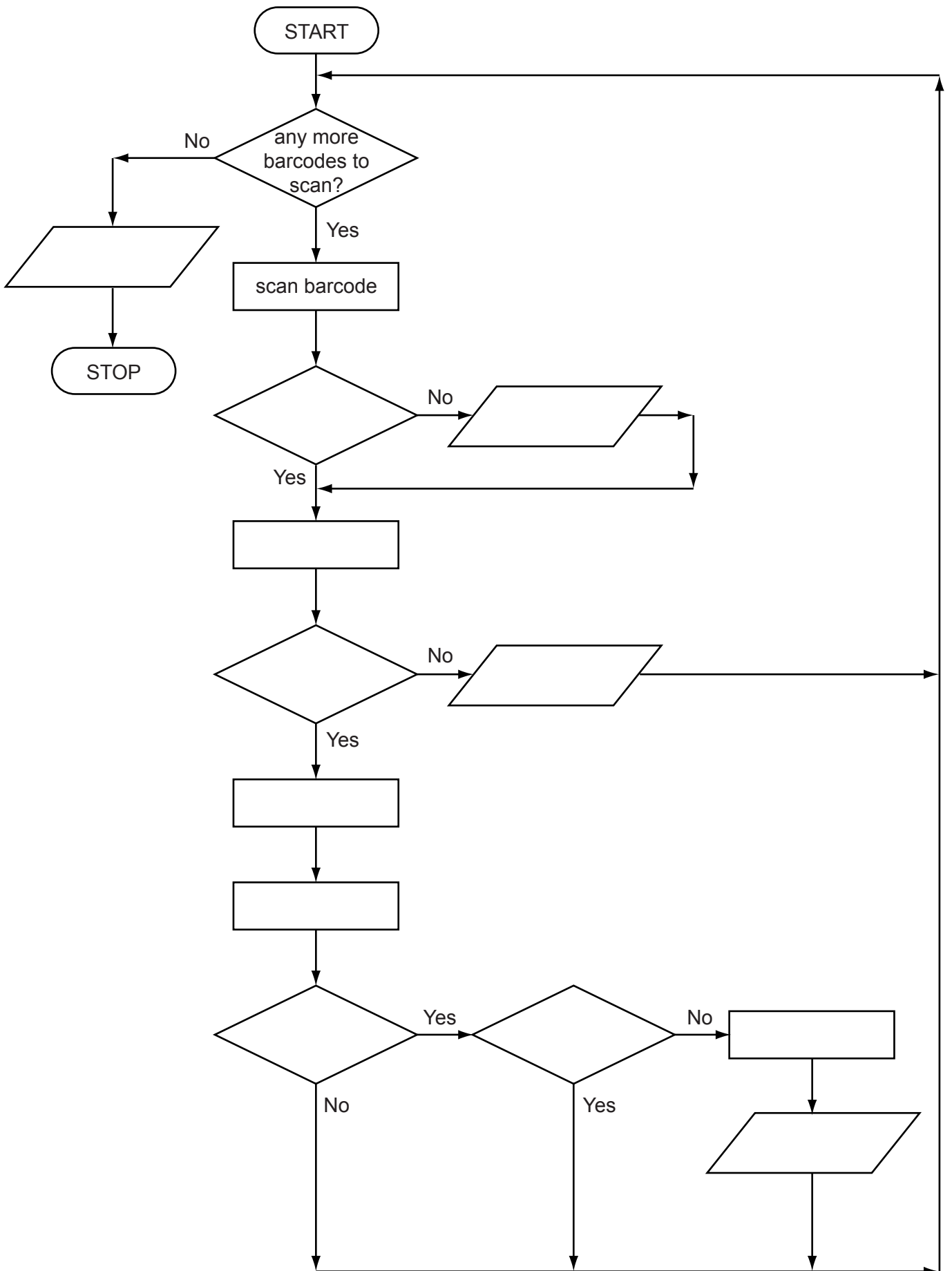

[8]

- (b) Two devices used by the supermarket Point-Of-Sale (POS) terminal are a barcode reader and a keyboard.

Name **two** other input/output devices used at the POS and give a use for **each** device.

device 1 .....

use .....

.....

.....

device 2 .....

use .....

.....

.....[4]

- 11 A spreadsheet was set up to find the value of gold jewellery. The purity of gold is measured in carats. Gold that is 24 carat is 100% pure. Other purities are measured as fractions of 24 carat. For example, 18 carat gold is  $\frac{18}{24} \times 100 = 75\%$  pure. Therefore, 20 grams of 18 carat jewellery would contain  $\frac{18}{24} \times 20 = 15$  grams of pure gold.

	A	B	C	D
1				
2	input number of carats of gold			
3	input weight of the jewellery (in grams)			
4	actual weight of gold (grams)			
5	input value of gold (\$ per gram)			
6	total value of gold (\$)			

Values are input into cells B2, B3 and B5 and output is shown in cells C4 and C6.

- (a) Cell C4 calculates the **actual** weight of gold in the original jewellery. What formula would you expect to be in cell C4?

= .....[1]

- (b) Cell C6 calculates the value of the gold content of the jewellery. What formula would you expect to be in cell C6?

= .....[1]

- (c) It was decided to include an extra input in D1. This additional input was the original amount paid for the gold jewellery (in \$). Cell D6 will now show whether the current sale value of the gold jewellery would generate a profit or not.

Complete the following formula in cell D6:

= IF (....., ".....", "no profit") [2]

- (d) A buyer bought some 18 carat gold jewellery for \$1500. The jewellery weighed 60 grams. The value of gold is \$40 per gram.

Show the values you would expect to see in cells B2, B3, B5, C4, C6, D1 and D6 using the following spreadsheet page:

	A	B	C	D
1			amount paid for jewellery (\$)	.....
2	input number of carats of gold	.....		
3	input weight of the jewellery (in grams)	.....		
4	actual weight of gold (grams)		.....	
5	input value of gold (\$ per gram)	.....		
6	total value of gold (\$)		.....	.....

[3]

12 An advertising sign uses large LED characters controlled by a microprocessor.

Each letter is formed from a grid made up of eight rectangles numbered 1 to 8:

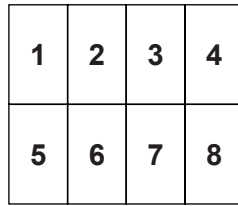

For example, the letter “Z” is formed as follows:

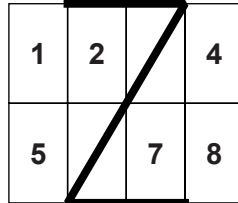

Each rectangle has six LEDs that can light up; these LEDs are labelled “a” to “f”:

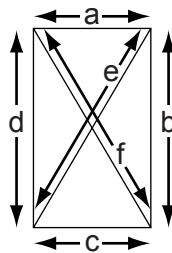

The LEDs in a rectangle can be represented in a 6-bit register. For example, rectangle 3 of the letter “Z”:

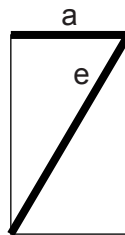

can be represented as:

f	e	d	c	b	a
0	1	0	0	0	1

Thus the letter “Z” can be represented by the 8 registers:

	f	e	d	c	b	a
1	0	0	0	0	0	0
2	0	0	0	0	0	1
3	0	1	0	0	0	1
4	0	0	0	0	0	0
5	0	0	0	0	0	0
6	0	1	0	1	0	0
7	0	0	0	1	0	0
8	0	0	0	0	0	0



(a) Show how the letter “E” can be represented by the eight 6-bit registers (four registers have been done for you).

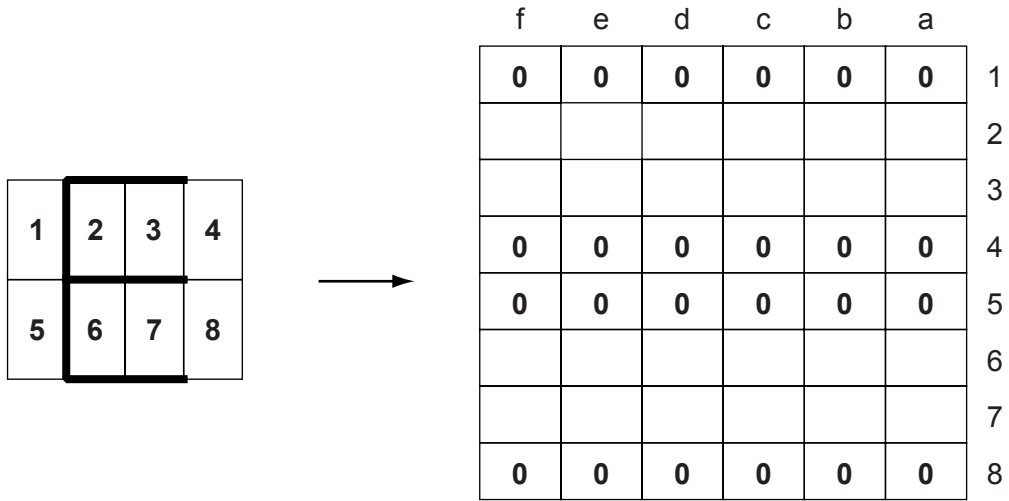

[4]

(b) State which letter of the alphabet is represented by the following eight 6-bit registers.

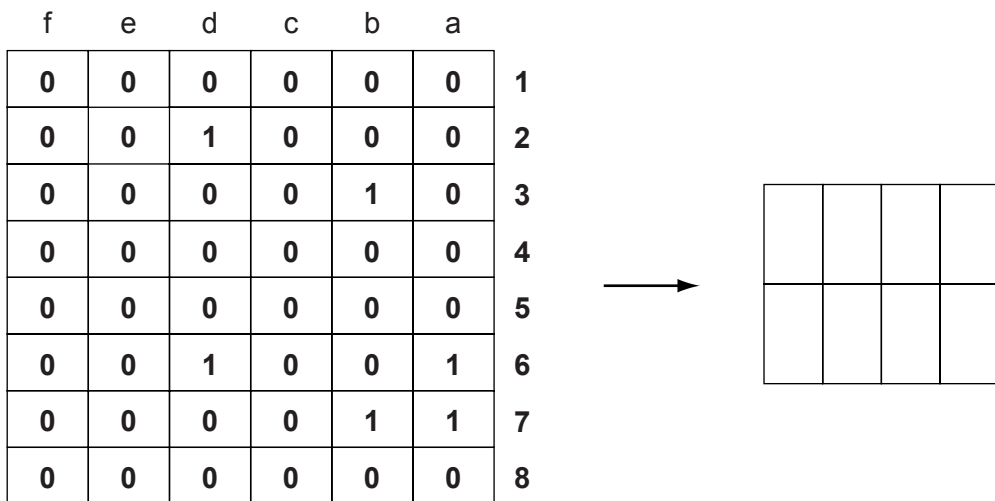

letter .....

[2]

13 (a) Complete the truth table for the following logic circuit:

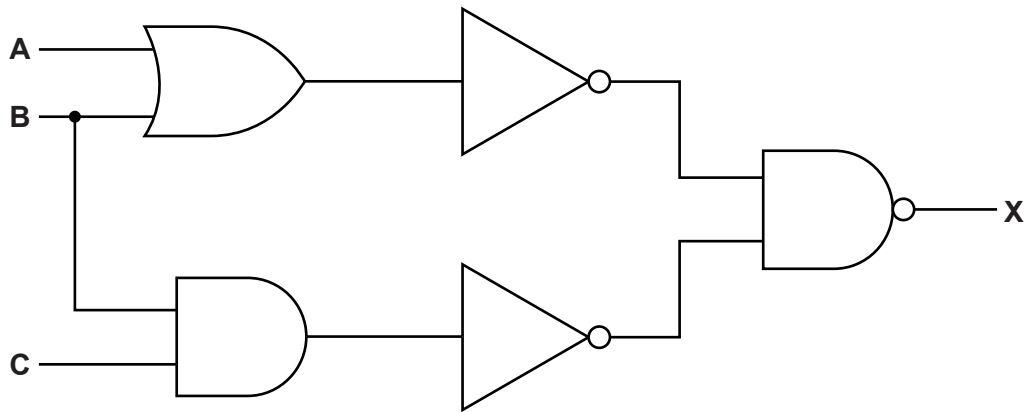

A	B	C	Working	X
0	0	0		
0	0	1		
0	1	0		
0	1	1		
1	0	0		
1	0	1		
1	1	0		
1	1	1		

[4]



14 Study the following flowchart very carefully.

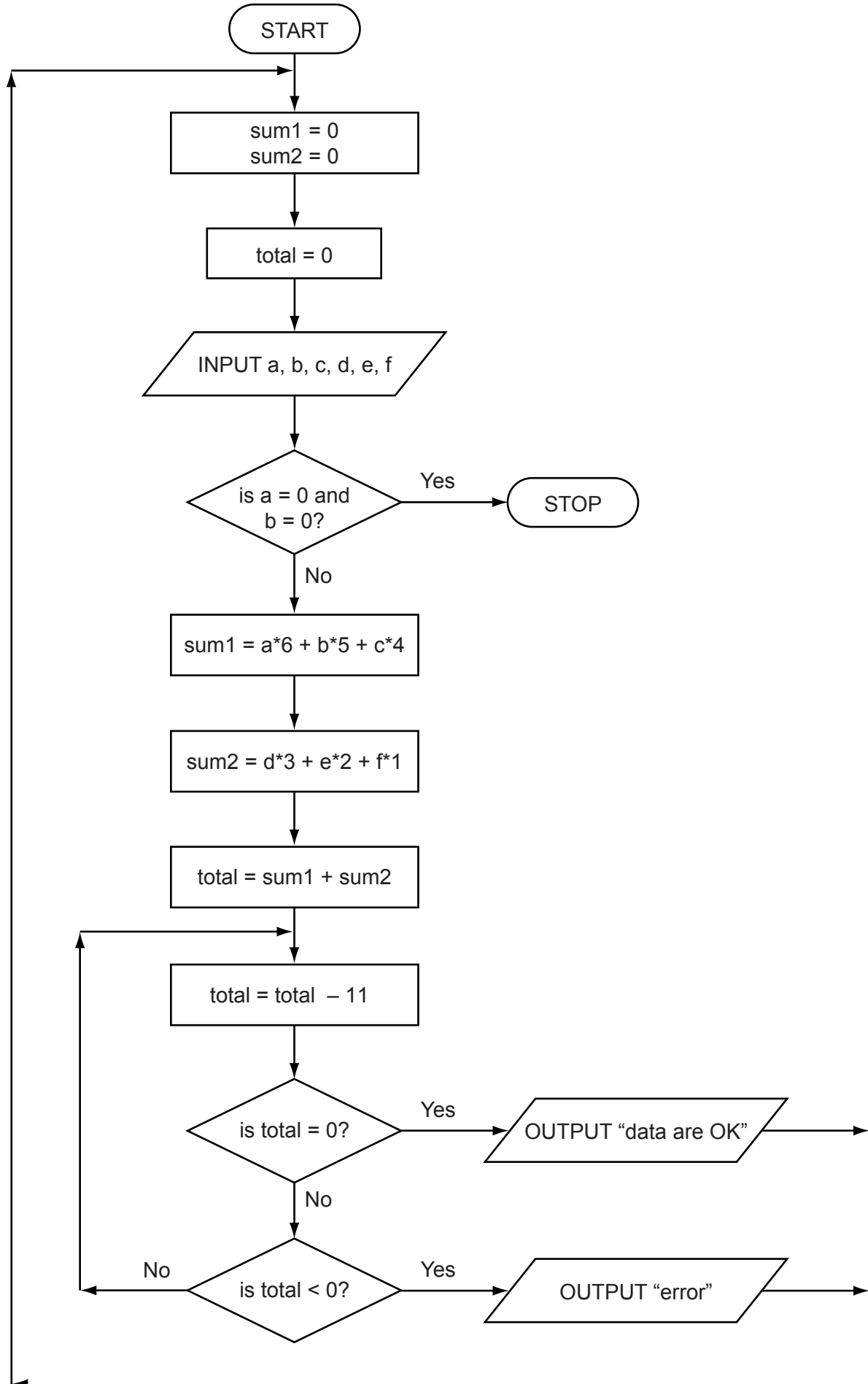



15 The following statement was produced using a word processor.

In New York City, all the taxis are painted yellow.  
This colour scheme for these taxis goes back many years.  
Taxis have to be changed every 3 years for safety reasons.  
All instructions inside the taxis are in English and Spanish since this is a dual language city.

Four changes were made to the original document using built-in word processing features. Note that all the changes are shown in shaded text.

In New York City, all the cabs are painted yellow.  
This colour scheme for these cabs goes back many years.  
Cabs have to be replaced every 3 years for safety reasons.  
Todas las instrucciones dentro de los taxis están en inglés y español puesto que esto es una ciudad dual de la lengua.

Describe four different word processing features that could have been used to make these changes.

- 1 .....
  - 2 .....
  - 3 .....
  - 4 .....
- [4]



**BLANK PAGE**

---

Permission to reproduce items where third-party owned material protected by copyright is included has been sought and cleared where possible. Every reasonable effort has been made by the publisher (UCLES) to trace copyright holders, but if any items requiring clearance have unwittingly been included, the publisher will be pleased to make amends at the earliest possible opportunity.

Cambridge International Examinations is part of the Cambridge Assessment Group. Cambridge Assessment is the brand name of University of Cambridge Local Examinations Syndicate (UCLES), which is itself a department of the University of Cambridge.